



Flywheeler

Design and technology

- Using mechanisms – gearing up
- Assembling components

Science

- Measuring distance
- Measuring time
- Forces
- Moving energy
- Friction and air
- Resistance
- Scientific investigation

Vocabulary

- Gearing up
- Flywheel
- Mass
- Position

Other materials required

- 3-metre strip of smooth floor
- Masking tape
- Metre rule or measuring tape
- Timer or stopwatch

Connect

Jack and Jill have had a little quarrel and have been sent outside to cool down. Jill gets Zog the Dog to pull her on the cart, but it is far too slow.

Jack plays with his spinning tops. They spin very fast but really he would much rather be friends with Jill and play with her again. Jill feels exactly the same – it is much better when they are good friends, and quite frankly, they are bored playing games that are not fun.

They look at each other and suddenly Jill gets an idea. How about a combined game using both the cart AND the power of the spinner? Will that work, do you think?

Could the spinning of a spinning top help a push-along car move and will it travel further – and for a longer time?

Let's find out!



Construct

First make the test track

Mark out a 50 cm section of run-up track. This is the run-up zone and in front of the launch line. Then stick a 2 m strip of masking tape along the floor and mark it off every 10 cm. Now we are ready to build models!

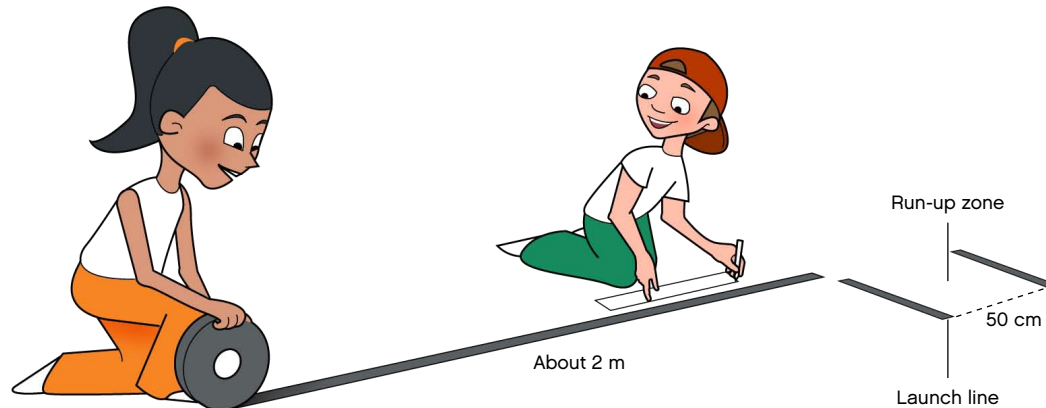

Build the Flywheeler

(all of book 10A and book 10B to page 10, step 20).

- When pushed it should roll to a stop quite slowly
- If it slows too soon, loosen the axle bushings, make sure gears are meshing properly, and make sure all other elements are pressed firmly together

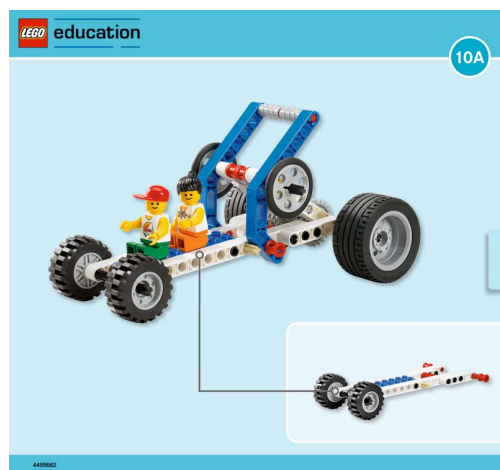
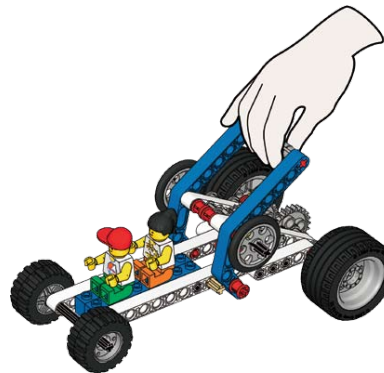

Contemplate

Fair testing

To fair test each model, use a 2-second run-up over 50 cm and release at the launch line – at the same speed. It takes practice! This is why it is a good idea to test each model 3 times to be sure.

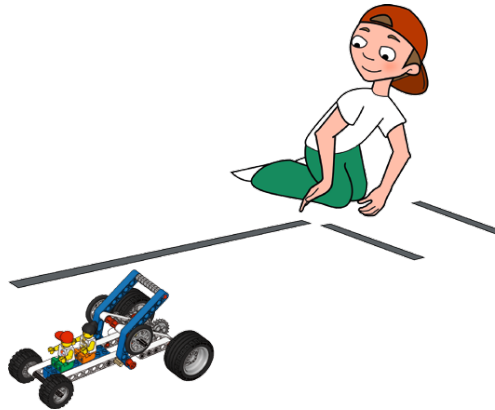

What makes a good flywheel?

The best flywheel will carry the model further, and roll for a longer time – with exactly the same run up! Try it without any flywheels at all! Try the big hub with and without its tyre. Invent your own combinations too.

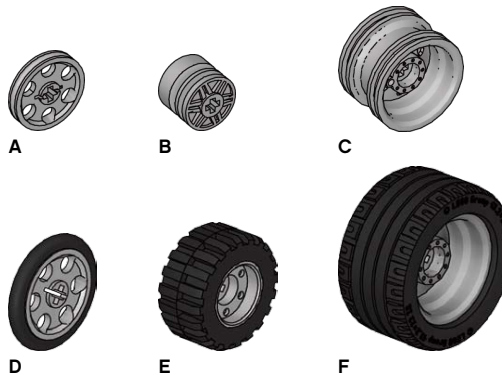

How far and for how long will it roll?

Measure how far each flywheel rolls. Even better, but optional, time how long it rolled for!

Build onto page 12, step 22.
Test and measure.

Build onto page 14, step 24.
Test and measure.

Did you know?

The best energy storing flywheels are put inside an airtight case and run in a vacuum to remove air resistance!

Did you know?

We use 8-tooth and 24-tooth gears to gear up. There are two gearing-up stages, each 1:3, i.e. one turn of the wheel on the ground gives 9 turns of the flywheel.

Continue

Shakey Brakey!

(book 10B page 17, step 3 with a flywheel mounted OFF centre).
Predict what will happen – then test it.

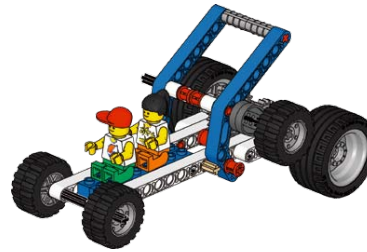

Try rolling Shakey Brakey down the hill.
What happens? Compare it to rolling with the balanced flywheel.

The Hill Climber

Make a ramp for the cars to run up. Predict and test how a flywheel and a non-flywheel car will perform with the same speed run up (this can be tricky!). You may want to work with some of the other teams in class on this activity.

Plank approx.
1 m long

Approx.
20 cm

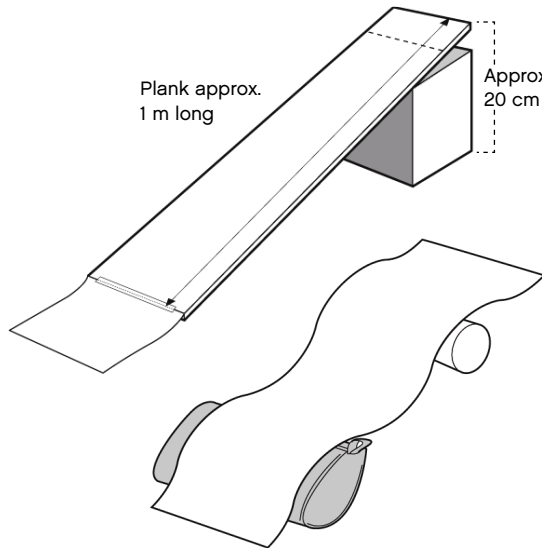

Make a series of low hills for the cars to negotiate. Thin card taped over shoes or objects works well.

Taking on an Obstacle Course

Make a big pile of LEGO® bricks on the floor or on the table and find out which type of flywheel it will take to cross the LEGO “mountain”.

Did you know?
In real life, an off-balance super fast flywheel can explode!